

SIXPAR 100 IP™

SKU# SIX001



Dimensional Drawings

Specifications are subject to change without any prior written notice.

Weight: 9.0 lbs. (4.1 kg)

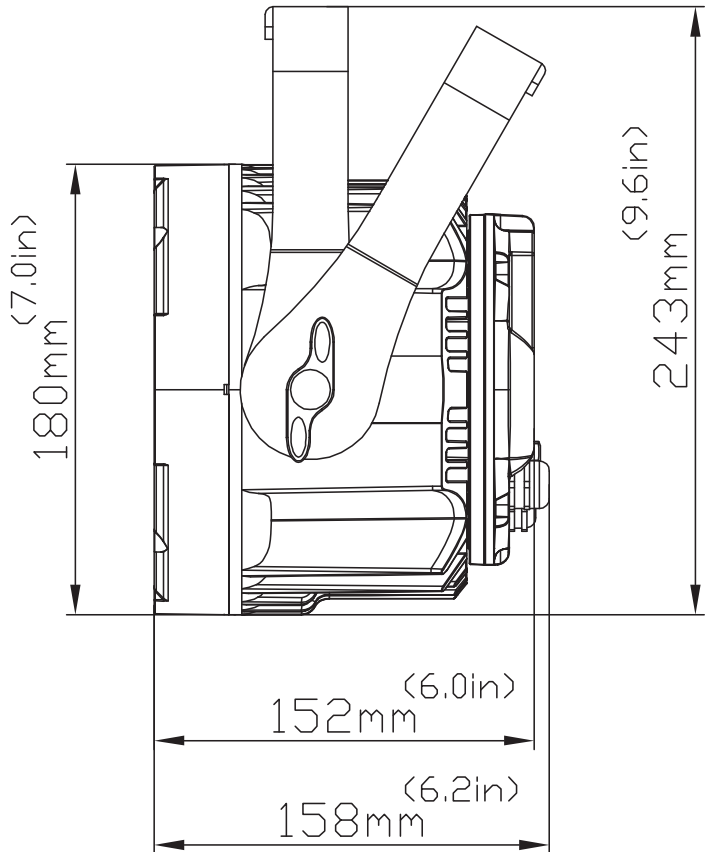
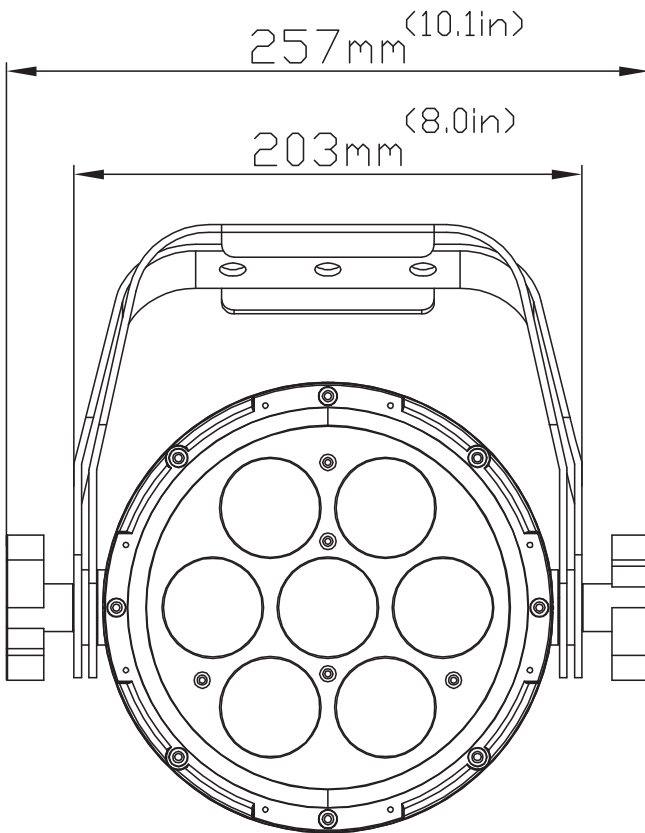

Elation Professional USA | 6122 S. Eastern Ave. | Los Angeles, CA. 90040
323-582-3322 | 323-832-9142 fax | www.elationlighting.com | info@elationlighting.com

Elation Professional B.V. | Junostraat 2 | 6468 EW Kerkrade, Netherlands
+31 45 546 85 66 | +31 45 546 85 96 fax | www.elationlighting.eu | info@elationlighting.eu